

100% TRAY INSPECTION

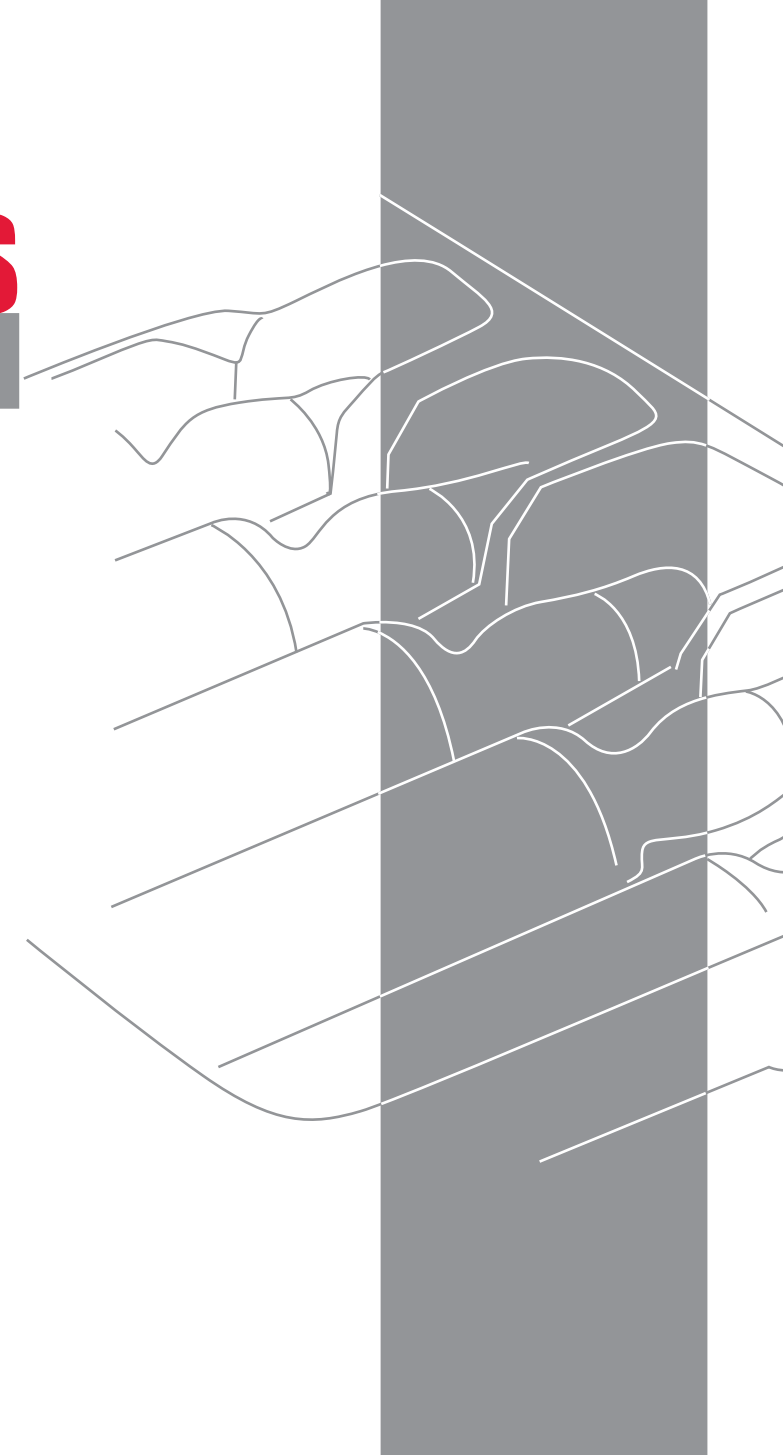
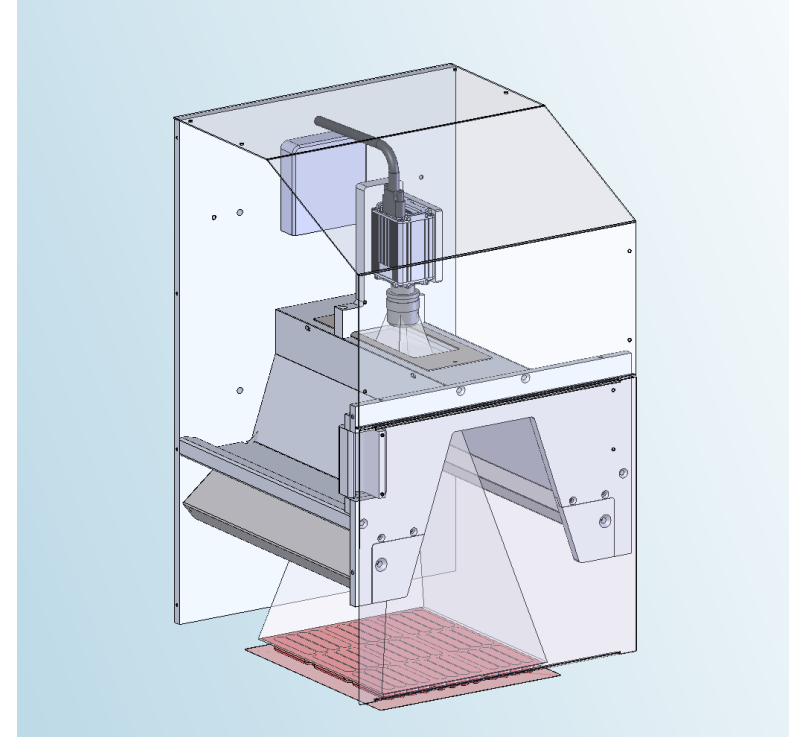

### TECHNICAL CHARACTERISTICS

#### IMAGING PERFORMANCES

Camera type	Colour CCD Gigabit Ethernet
Resolution	Up to 1600 x 1200 pixels
Inspection area	Up to 270 x 360mm
Analyzer	Real time operating system
Lighting	Cold white light, high power LEDs
Led duration	Over 30.000 hours
Image quality optimization through dedicated HW and SW	Yes
Direct strobo lighting	Yes
Backlight strobo lighting	Optional
Imaging and processing speed	Virtually unlimited

#### SOFTWARE FEATURES

Self-learning procedure (wizard)	Yes
Light auto-adjustment and compensation	Yes
Automatic threshold tuning from last errors	Yes
Image errors storage (for automatic threshold adjusting and visual analysis)	50
Multi-language platform	Yes
Available languages	English, French, Italian, German, Spanish, other languages available on request

#### HMI

Display	Stand alone 15" touch screen display or fully integrable in the machine HMI
Hardware	Solid state disk and custom buttons on panel

#### SECURITY AND VALIDATION

User login levels	Configurable, up to 5 levels
FDA 21 CFR part 11 compliant	Yes
Alarms on signals	Correct tray, empty tray, incomplete tray, foreign product detection
Development according to GAMP 5 rules	Yes

#### REMOTE ASSISTANCE

Remote support through network connection	Yes
---	-----



Antares Vision srl - via Roncadelle, 70A - Castel Mella - Brescia - ITALY - Tel. +39 030 8374694 / Fax +39 030 5109958 info@antaresvision.com www.antaresvision.com

# PIC PACKAGE INTEGRITY CONTROL



# PIC PACKAGE INTEGRITY CONTROL

The Package Integrity Control is the solution designed to inspect pharmaceutical products such as syringes, ampoules, bottles or vials in trays.

The system is easily integrable in thermoforming machines and it checks for the presence, the shape, the colour and the integrity of all the products inside the pockets before the sealing through specific controls for each type of package and product.

The PIC is integrated into the Antares Vision architecture and may therefore be integrated with all traditional line controls such as blister inspection, all the Universal Packaging Inspector suite, as well as all the Track and Trace systems.

## FEATURES AND BENEFITS

### IT WORKS WITH ANY KIND OF PRODUCT AND MATERIAL

- Inspected products (image 1):
  - syringes
  - ampoules
  - bottles
  - vials
- Materials:
  - plastic
  - glass
  - metal

### IT WORKS WITH ANY SUPPORT TRAY

- Any material: PVC, PET-G, and PET are the most commonly used thermoformed materials, but the PIC works even with cardboard.
- Any shape: single or combo pack trays. (image 2)

### 100% INSPECTION

- Presence and integrity:
  - Package filling (images 3-4)
  - Syringe needle and stopper (image 4)
  - Cap and flip-off closure (image 5)
  - Glass and plastic integrity (image 6)
- Shape check (image 4):
  - Product shape check
  - Geometry (area, contour, major/minor axis)
- Colour check:
  - Product colour (image 6)
  - Rings on ampoules (image 3)
  - Single inner part colour, as syringe piston and stopper (image 4)

### SMART AND EFFICIENT

- The PIC inspects up to 12 trays, each one containing up to 40 different check areas, thanks to the high resolution colour camera (up to 1600x1200 pixels).
- Simple and fast self-learning procedure: the software guides the operator along the phases of format creation. (image 7)
- Easy and user-friendly graphic user interface based on stand alone 15" touch screen display or directly integrated in the machine HMI. (image 8)
- An automatic self-tuning procedure optimizes illuminator set up, product colour selection and tray position detection. (image 9)
- Advanced statistical analyses with detailed reject typology identification, to help detecting the reject causes in the upstream production process. (image 10)
- The highest reliability is assured by image processing performed with real time-embedded technology and by the total absence of critical components such as hard disks.

### QUALITY AND VALIDATION

- Manages up to 5 user login levels.
- FDA 21 CFR part 11 and GMP Annex 11 compliant.
- Developed following GAMP 5 approach.
- Availability of all documentations involved in the GAMP approach.



1



2

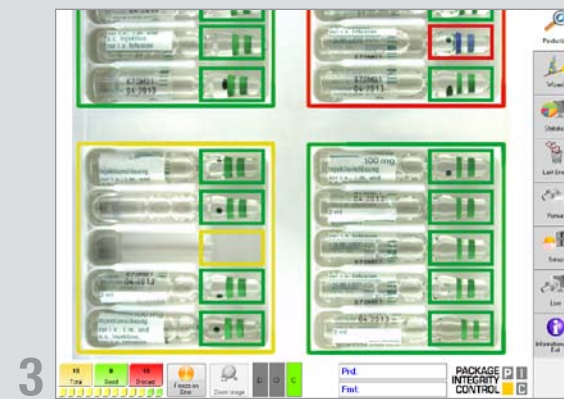

3

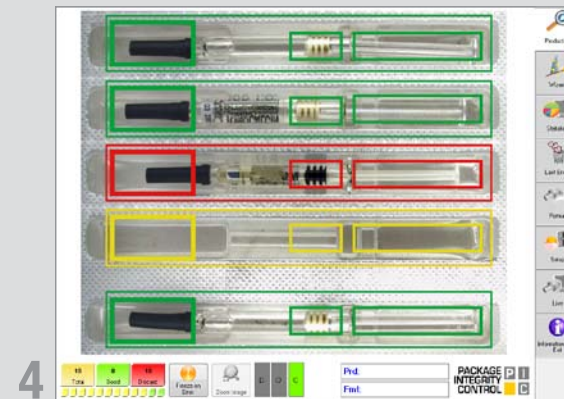

4



5

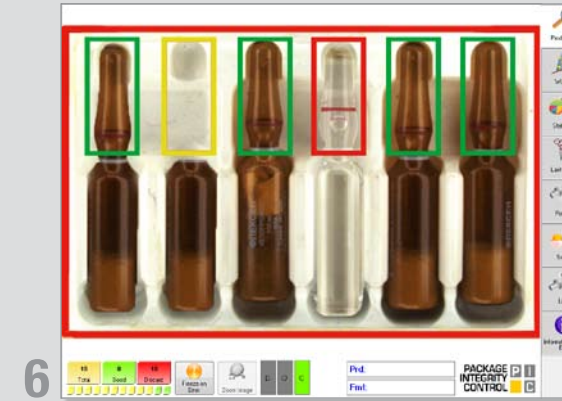

6



7

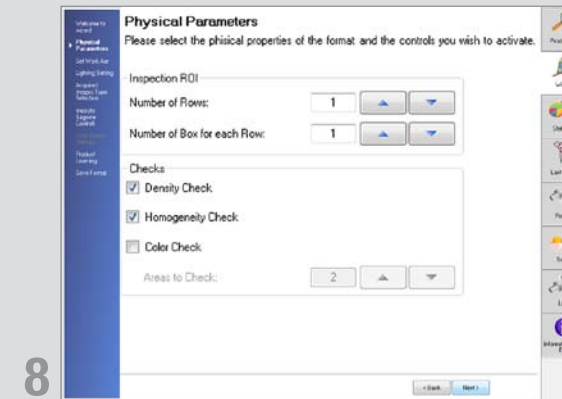

8

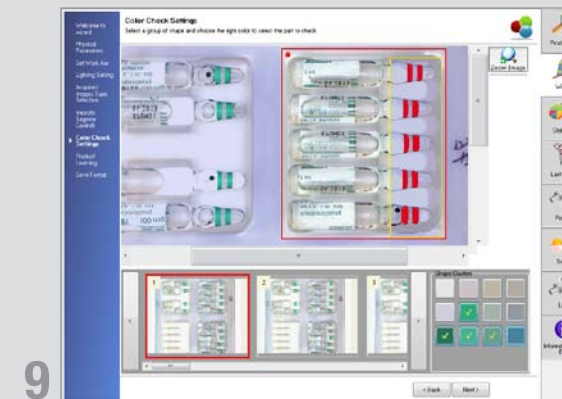

9

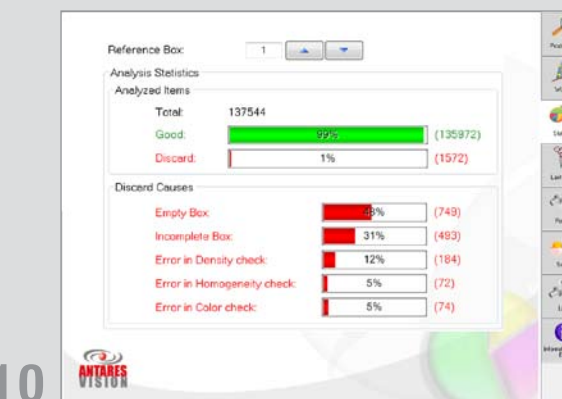

10